

POTAIN

MC 78

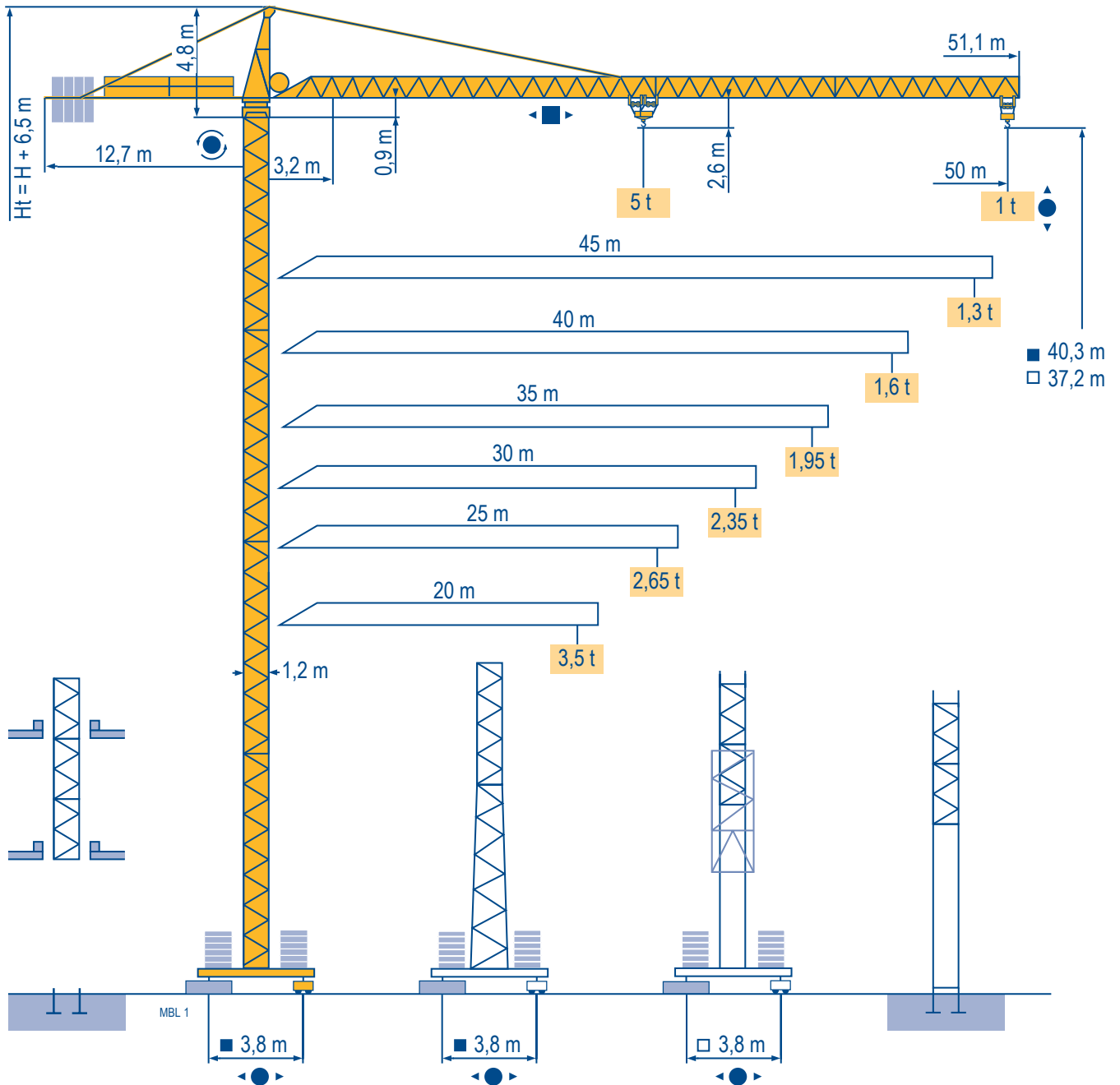

CITY CRANE

CE FEM 1.001-A3

Mat / Réactions \square 1,2 m

Maste /
Eckdrücke
Masts /
Reactions
Mástil /
Reacciones
Torre / Reazioni
Tramo /
Reacções

MBL 2

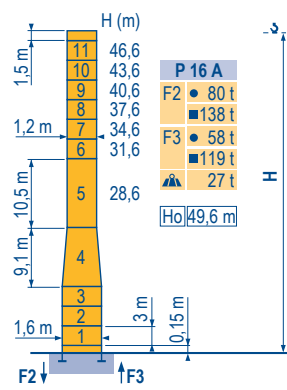
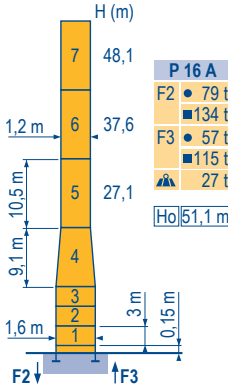
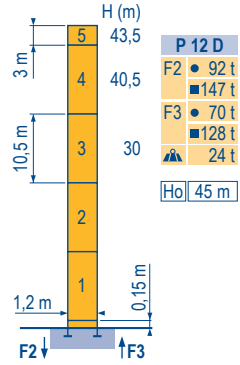
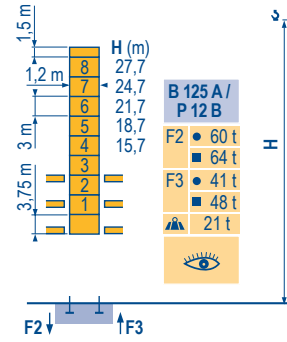
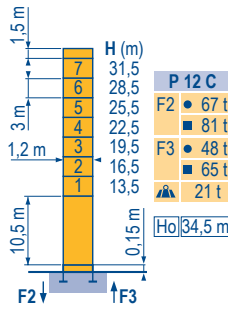
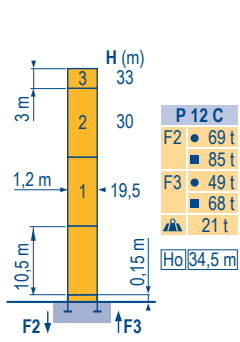

\square 1,2 m
20 m \Rightarrow 50 m

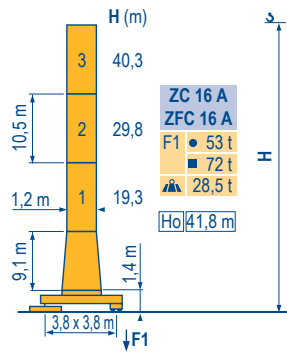
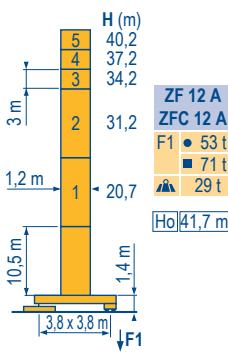
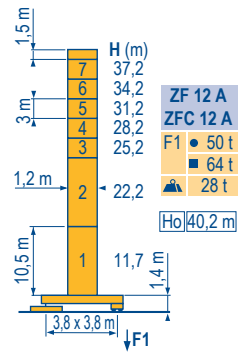

ZF - ZC - ZFC

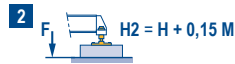

CITY CRANE MC 78

POTAIN

| F | D | GB | E | I | P |
|--|---|--|---|--|--|
| | | | | | |
| Réactions en service | Reaktionskräfte in Betrieb | Reactions in service | Reacciones en servicio | Reazioni in servizio | Reacções em serviço |
| Réactions hors service | Reaktionskräfte außer Betrieb | Reactions out of service | Reacciones fuera de servicio | Reazioni fuori servizio | Reacções fora de serviço |
| A vide sans lest (ni train de transport) avec flèche et hauteur maximum. | Ohne Last, Ballast (und Transportachse), mit Maximalausleger und Maximalhöhe. | Without load, ballast (or transport axles), with maximum jib and maximum height. | Sin carga, sin lastre, (ni tren de transporte), flecha y altura máxima. | A vuoto, senza zavorra (ne assali di trasporto) con braccio massimo e altezza massima. | Sem carga (nem trem de transporte)- sem lastro com lança e altura máximas. |
| Ho | H | H | H | H | H |
| H sans cabine | H Ohne Fahrerhaus | H without cab | H sin cabina | H senza cabina | H sem cabine |

Courbes de charges

Lastkurven

Load diagrams

Curvas de cargas

Curve di carico

Curva de cargas

MBL 1

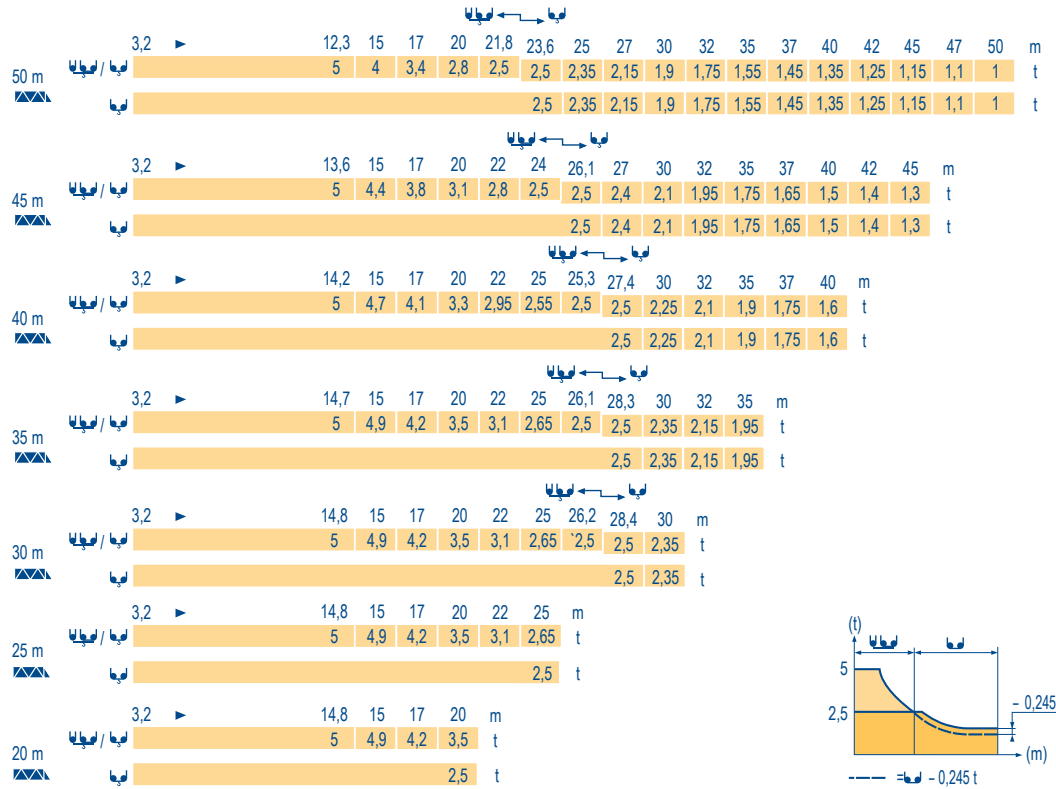

Télescopage sur dalles
Kletterkrane im Gebäude
Climbing crane
Telescopage gruas trepadoras
Gru in cavedio
Telescopagem sobre lages

MBL 1

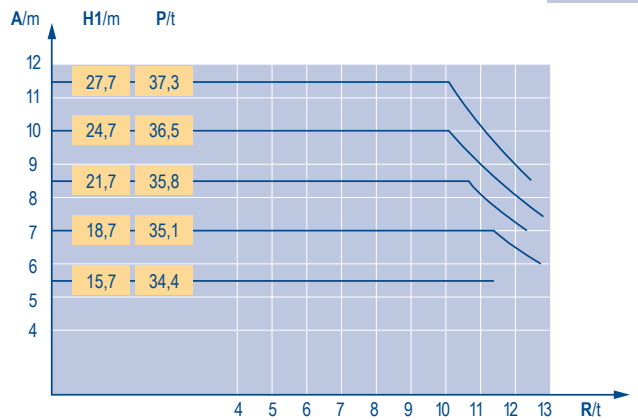
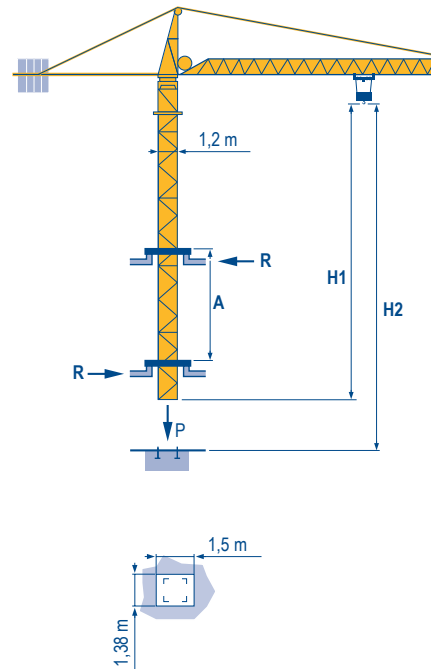

CITY CRANE
MC 78



| | F | D | GB | E | I | P |
|-----------|------------------------------|-------------------------------|---------------------------|-------------------------------|------------------------------|------------------------------|
| A | Distance entre cadres | Abstand zwischen den Rahmen | Distance between collars | Distancia entra marcos | Distanza fra i telai | Distância entre quadros |
| H1 | Hauteur grue | Kranhöhe | Crane height | Altura grúa | Altezza gru | Altura da grua |
| P | Poids de la grue(en service) | Krangewicht (in Betrieb) | Crane weight (in service) | Peso de la grúa (en servicio) | Peso della gru (in servizio) | Peso da grua (em serviço) |
| R | Réaction horizontale | Horizontalkräfte | Horizontal reaction | Reaccion horizontal | Reazione orizzontale | Reacção horizontal |
| | Voir télescopage sur dalles | Siehe Kletterkrane im Gebäude | See climbing crane | Veja grua trepadora | Consultare gru in cavedio | Ver telescopagem sobre lages |

Mécanismes
Antriebe
Mechanisms
Meccanismi
Mecanismos

MBL 2

| | | | U | | | UU | | | ch - PS hp | kW | |
|------------------------|---------------|------------------------|----------------------|------|-----|---|------|------|---------------|---------|-------|
| | | | | | | | | | | | |
| | 15 PC 13-6 | m/min | 7,2 | 21,5 | 43 | 3,6 | 11 | 21,5 | 15 | 11 | 185 m |
| | | t | 2,5 | 2,5 | 1,3 | 5 | 5 | 2,6 | | | |
| | 25 PC 13-8 | m/min | 8,2 | 33 | 66 | 4,1 | 16,5 | 33 | 25 | 18 | 323 m |
| | | t | 2,5 | 2,5 | 1,3 | 5 | 5 | 2,6 | | | |
| | 20 LVF 13 | m/min | 5 → 28,4 → 52,6 → 69 | | | 2,5 → 14,4 → 26,3 → 34,5 | | | 20 | 15 | 323 m |
| | | t | 2,5 | 2,5 | 1,3 | 0,65 | 5 | 5 | | | |
| | 4 D3 V3 | m/min | 15 - 30 - 58 | | | | | | 4 | 3 | |
| | RVCV 60 | tr/min U/min rpm | 0 → 0,8 | | | | | | 8 | 6 | |
| | TVD 324 | m/min | 26 | | | | | | 2 x 4 | 2 x 2,9 | |
| | RT 224 | m/min | 25 | | | | | | 2 x 4 | 2 x 2,9 | |
| CEI 38 | | | IEC 38 | | | kVA | | | | | |
| 400 V (+6% -10%) 50 Hz | | | | | | 15 PC : 30 kVA 25 PC : 35 kVA 20 LVF : 30 kVA | | | | | |

| | F | D | GB | E | I | P |
|--|--------------|------------|------------|--------------|---------------|--------------|
| | Levage | Heben | Hoisting | Elevación | Sollevamento | Elevação |
| | Distribution | Katzfahren | Trolleying | Distribución | Distribuzione | Distribuição |
| | Orientation | Schwenken | Slewing | Orientación | Rotazione | Rotação |
| | Translation | Kranfahren | Travelling | Traslación | Traslazione | Translação |

Document commercial non contractuel. Pour toute information technique se référer à la notice correspondante. Unverbindliches Vertriebsdokument. Für technische Informationen, siehe die entsprechenden Anweisungen. This commercial document is not legally binding. For any technical information, please refer to the corresponding instructions. Documento comercial non contractuel. Para cualquier información técnica, ver la noticia correspondiente. Documento commerciale non vincolante, per tutte le informazioni tecniche fare riferimento al catalogo istruzioni. Documento comercial não contratual. Para qualquer informação técnica complementar consultar as respectivas instruções.



Americas
Tel : +1 888 479 7278
Tel : +1 717 593 2000

Europe – Middle East – Africa
Tel : +33 (0) 4 72 81 50 00
Tel : +44 (0) 191 522 2000

Asia – Pacific
Tel : +65 6264 1188
Fax : +65 6862 4142

www.manitowoccrane.com

18, rue de Charbonnières - B.R.173
69132 ECULLY Cedex - France
Tél. : +33 (0) 4 72 18 20 20
Fax. : +33 (0) 4 72 18 20 00
www.manitowoccrane.com

CITY CRANE MC 78
Réf. 2004 39 MBL 3

Copyright.Reproduction interdite © POTAIN 2004

Réalisation Secotec